

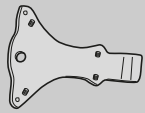

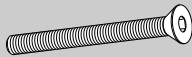
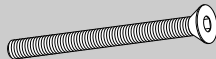

SR1155 - KR1155

PORTAPACCO SPECIFICO - SPECIFIC HOLDER - PORTE-PAQUET SPÉCIFIQUE - SPEZIFISCHER TRÄGER - PORTA-EQUIPAJE ESPECÍFICO

HONDA SH 125/SH 150(2009/2016)/ HONDA SH 125/150(2017)/ HONDA SH 300(2015/2017)

N°	Descrizione	Caratteristiche	Codice	Quantità	
1	Supporto - Support - Support Halterung - Soporte - Apoio	-	-	1	
2	Vite - Screw Vis - Schraube Tornillo - Parafuso	TSP M8x65	865TSP	1	
3	Vite - Screw Vis - Schraube Tornillo - Parafuso	TSP M8x75	875TSP	1	
4	Dado - Bolt - Ecrou Mutter - Tuerca - Porca	Dado Autobloccante Flangiato Ribassato M6	6DADIABFN	4	
5	Distanziale - Spacer Entretoise - Distanzstueck Distanciador - Espaçador	Ø20L35Foro8,5mm	C20L35F8,5T	1	
6	Distanziale - Spacer Entretoise - Distanzstueck Distanciador - Espaçador	Ø20L10Foro8,5mm	C20L10F8,5T	1	
7	Distanziale - Spacer Entretoise - Distanzstueck Distanciador - Espaçador	Ø18L18Foro8,5mm	C18L18F8,5T	1	
8	Particolari Inclusi Nel Kit Viteria Della Piastra Components Included In The Fitting Kit Of The Plate Pièces Incluses Dans Le Kit De Vis De La Platine Die Einzelnen Teile Sind Bei Montagetkit Der Platte Enthalten Despieces Incluidos En El Kit De Anclajes De La Parrilla				

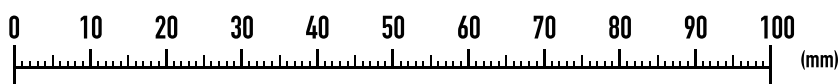
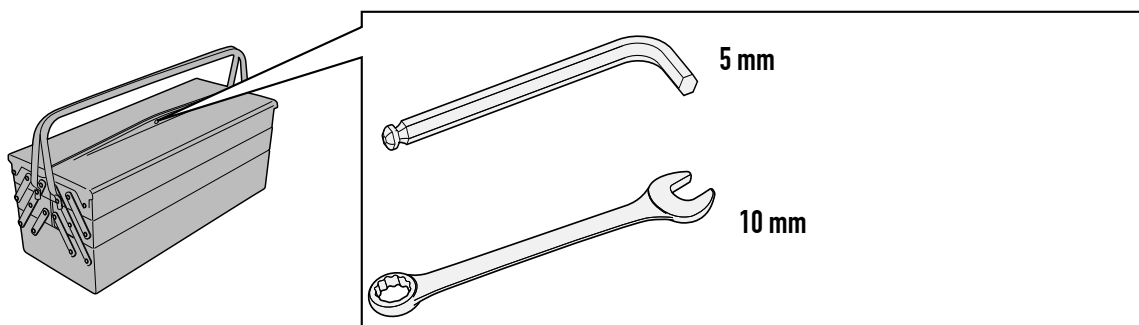

SR1155 - KR1155

PORTAPACCO SPECIFICO - SPECIFIC HOLDER - PORTE-PAQUET SPÉCIFIQUE - SPEZIFISCHER TRÄGER - PORTA-EQUIPAJE ESPECÍFICO

HONDA SH 125/SH 150(2009/2016)/ HONDA SH 125/150(2017)/

HONDA SH 300(2015/2017)

HONDA SH 125/ SH 150(2009/2016)

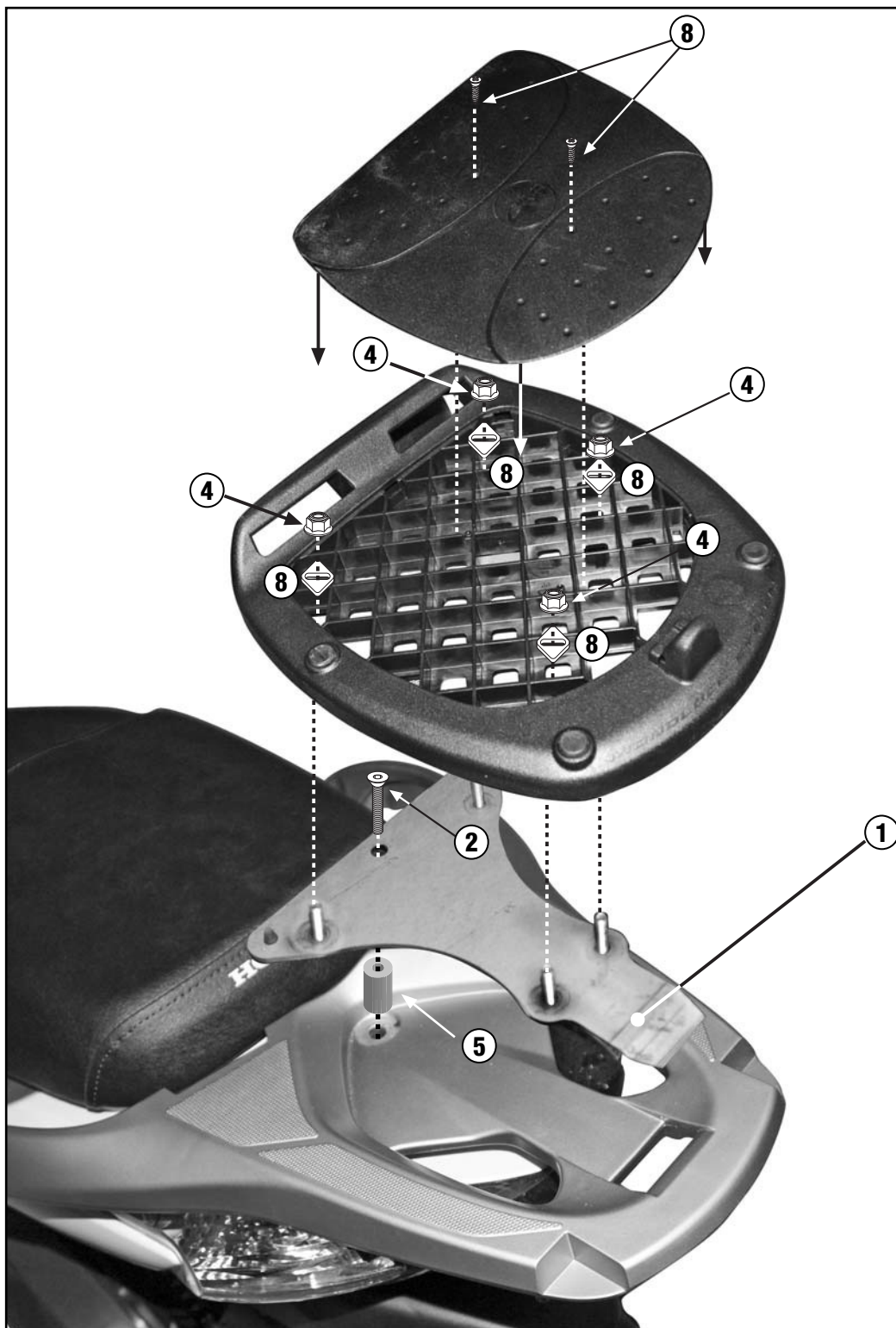

ISTRUZIONI DI MONTAGGIO - MOUNTING INSTRUCTIONS
INSTRUCTIONS DE MONTAGE - BAUANLEITUNG
INSTRUCCIONES DE MONTAJE - INSTRUÇÕES DE MONTAGEM

SR1155 - KR1155

PORTAPACCO SPECIFICO - SPECIFIC HOLDER - PORTE-PAQUET SPÉCIFIQUE - SPEZIFISCHER TRÄGER - PORTA-EQUIPAJE ESPECÍFICO

HONDA SH 125/SH 150(2009/2016)/ HONDA SH 125/150(2017)/

HONDA SH 300(2015/2017)

HONDA SH 125/ SH 150 (2017)

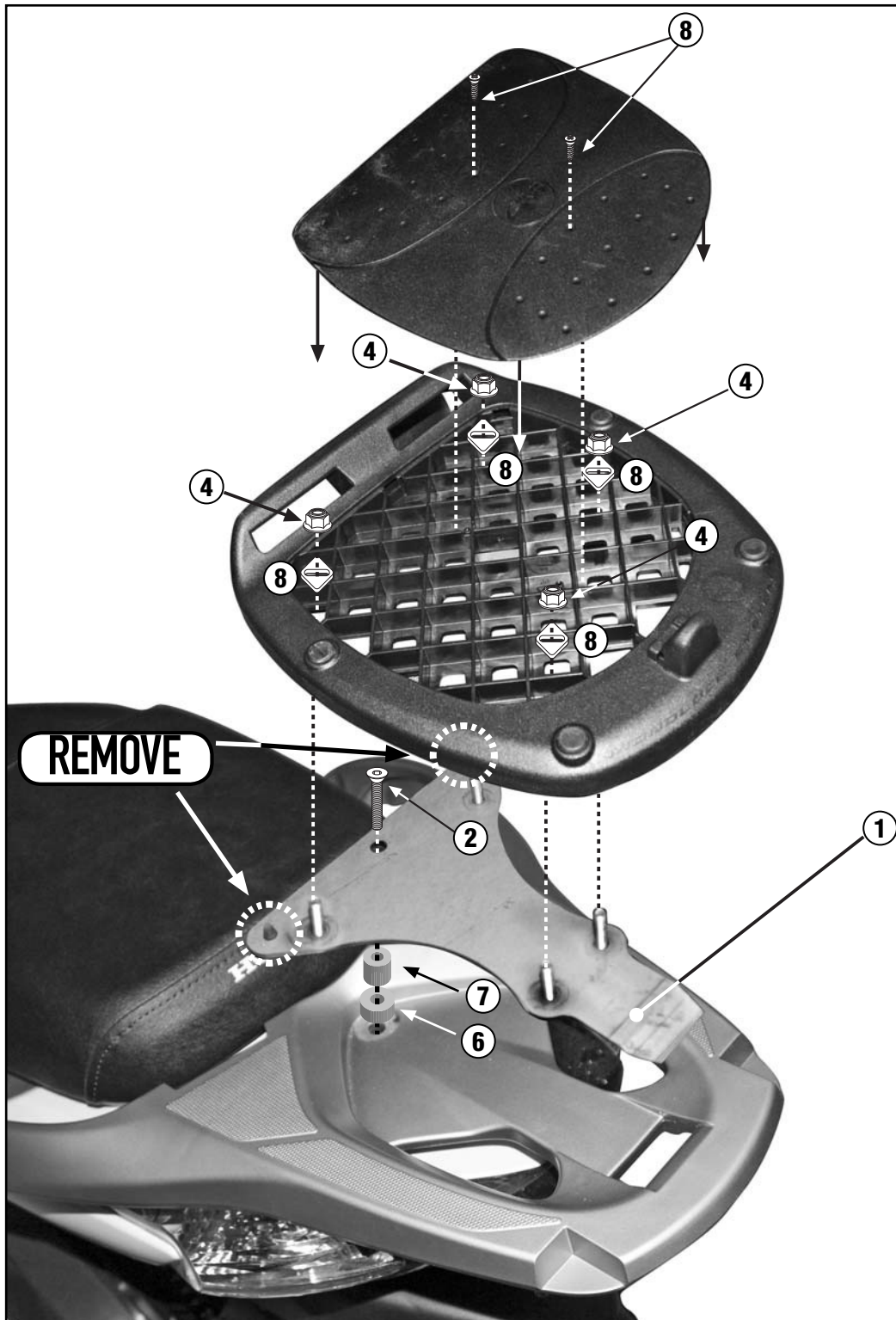

SR1155 - KR1155

PORTAPACCO SPECIFICO - SPECIFIC HOLDER - PORTE-PAQUET SPÉCIFIQUE - SPEZIFISCHER TRÄGER - PORTA-EQUIPAJE ESPECÍFICO

HONDA SH 125/SH 150(2009/2016)/ HONDA SH 125/150(2017)/

HONDA SH 300(2015/2017)

HONDA SH300 (2015/2017)

